

Medium pressure – Plastic industrial fan

Agent :

For use in Ex zones

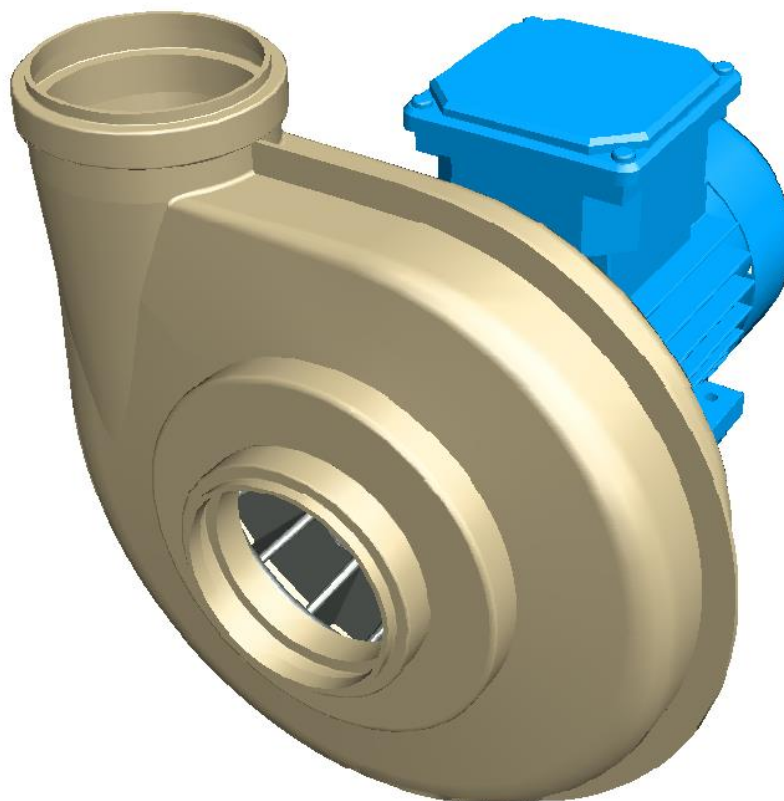



Not for use in Ex zones

Preface

This operating manual is the driver's license for the operation of this COLASIT fan. It is the main source of information and also the safety guideline. It deserves your full attention - please read it carefully.

The contents of this operating manual are subject to change without notice in order to take technical progress into account. In order to match this operating manual to your COLASIT fan, please register the following particulars of the fan below, whereby reference should be made to the manufacturer's nameplate.

Whilst reading this manual, you will be guided by symbols which indicate dangers and especially important references.

	Very important reference
	Generally valid danger warnings which concern your personal safety
	Reference to electrical dangers
	Reference to dangers resulting from the process environment

The entire operating manual consists of 3 parts

Part 1: General

Part 2: Components

Part 3: Certification

Table of contents

Part 1: General	4
1 General	4
1.1 Definition	4
1.2 Manufacture of COLASIT fans	4
1.3 Warranty	4
1.4 Safety review	5
1.5 Qualification of personnel	5
1.6 Possible emergencies	5
1.7 The safety inspector (So)	5
1.8 General risk matrix	6
1.9 EU conformity of the COLASIT fan	7
1.10 Restrictions when commissioning	7
1.11 General operating conditions	7
2 Explosion protection	7
2.1 Fan EX marking	8
2.2 Correct installation of ATEX fan	9
3 Shipping, unpacking, inspection	9
4 Installation, configuration	9
5 Commissioning, initial start-up, test run	10
5.1 Inspection of the installation and settings	10
5.2 Drive	10
5.3 Electrical installations	10
6 Operation	11
6.1 Safety regulations	11
6.2 Decommissioning	11
7 Maintenance / repair / cleaning	11
7.1 Preparation	11
7.2 Performance	11
8 Spare parts	13
9 Operating instructions	13
10 Log-book	13
11 Disposal	13
12 Faults and fault clearance	13
13 Retrofittable original accessories	14
14 Fan identification	14
Part 2: Units	14
15 Design and function CCV 75	14
16 Dimensions	15
16.1 Dimensions of the CCV 75	15
17 Spare parts	16
17.1 Spare parts lists CCV 75	16
Part 3: Certifications	17
18 Certifications	17
18.1 EU Declaration of Conformity	17
18.2 ATEX-Declaration of Conformity	18
18.3 Further certificates	20
19 Form for the correct assembly ATEX-fans	21

Part 1: General

1 General

OBLIGATIONS

Prior to any work done on or with the fan, we put you under an obligation to read this operating manual and any further contractors' operating instructions carefully and through to the end.

Should anything not be clear, please get in touch with us immediately. Do not put the fan into operation as long as uncertainties exist.

With the commissioning of the fan you confirm that you have read and understood the operating manual.



After having become acquainted with the fan and its operational performance together with your production process, we recommend that you make a note of the different modes of operation in a "process instructions" document.

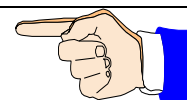

Together with this operating manual, any acceptance documents such as works acceptance certificates and the EU declaration of conformity, the process instructions document forms part of the complete system documentation.

For the fan, a separate risk analysis was made as a prerequisite for writing this operating manual. Risks were evaluated and any remaining residual risks are pointed out in this operating manual.

When extracting aggressive gases, it is imperative to review the suitability of the materials:

- Once the principal or the operator has notified us of the gas mix and the maximum operating temperature, the suitability and any applicable restrictions will be confirmed in the data sheet of COLASIT AG.
- **In the absence of a written notification with regard to the extracted medium by the principal, the operator is responsible without limitation for assessing the suitability for the operation of the ventilator.**

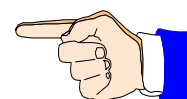

1.1 Definition

The term "COLASIT fan" stands for a Swiss high-quality product and contains all those components and individual parts, as compiled in the purchase order or in the material parts list respectively, which, when assembled, form a functional unit.

1.2 Manufacture of COLASIT fans

The fan was manufactured using to modern manufacturing methods and was extensively tested both during manufacture and as a finished product by the COLASIT quality assurance system. The methods and procedures used for manufacture and production monitoring correspond to the state of the art. The personnel entrusted with the manufacture of the fan have the appropriate skills and possess valid qualifications.

All fans complete a successful test run in the manufacturer's facilities.

1.3 Warranty

The warranty ends on the date stated in the general terms of sale and delivery. Warranty is limited to the delivery of spare parts or the repair of defective parts in the manufacturer's works. Any further claims or the replacement of expendable items or of items subject to normal wear and tear are excluded.

We guarantee the availability of spare parts identical in construction to the original over a period of 10 years effective from the date of delivery.

COLASIT only guarantees the stability of materials under the condition that technological data was available before production.

Any change in the conditions of use is only permissible after approval by COLASIT; otherwise this entails the loss of warranty.

Any changes or repair work during the warranty period may only be made by our fitters or with our written consent.

We refer to the limitation of warranty noted in the “drive” section in the case where a frequency converter supplied by a third party is used.

The fan must be deployed and used in accordance with the conditions mentioned in this operating manual. Only in this way can its function be guaranteed and dangers for persons and material be excluded during operation. We accept no responsibility or guarantee claims for damages arising from non-observance of this manual or from inappropriate operation.

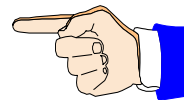

1.4 Safety review

After having installed the fan, we recommend checking out the entire operating situation by means of a risk analysis. In this way it can be guaranteed that neither the fan suffers damage nor that the fan causes any damage. Please make a record of this review in a report.

1.5 Qualification of personnel

The fan must only be put into operation, handled, operated, maintained and cleaned by trained personnel who are authorised (and competent) to carry out such work.

The personnel must possess the appropriate skills needed to operate the fan and be familiar with the effects of the reactions caused by the fan.

The personnel qualified for the operation of the fan must be able to react adequately and correctly in the case of a fault or an emergency.

1.6 Possible emergencies

An emergency results from the bursting or melting of plastic components as a result of mechanical damage or chemical and thermal influences. In this case, parts may fly off and vapours may be produced which could be hot, corrosive, poisonous, irritating or inflammable.

A danger of fire exists under certain conditions.

For the choice of the correct fire-extinguishing devices and the positioning of the fire-fighting equipment, please follow the recommendations of your official fire-prevention agency.

1.7 The safety inspector (So)

The function of the safety inspector or his representative is defined in the operating company's organisational chart. The name of the person must be known to all personnel who are responsible for the fan. The operating company defines his competencies and his area of responsibility.

The safety inspector approves the fan for operation.

1.8 General risk matrix

Operation

The safety regulations in effect at the operator's location are mandatory and are to be observed at all times. During operation, parts of the body or objects must never be brought within the reach of the fan. Before making an intervention, the process must be stopped i.e. all mechanical movement is to be stopped and it is to be ensured that no self-acting motion can occur.



Missing protective equipment

If the fan is equipped with safety equipment, this equipment must neither be modified nor removed. Further protective devices of a suitable construction are to be mounted by the operator and are subject to his control.



Disregard of safety precautions

Please implement all safety measures, in order that the fan, together with its associated equipment, works properly and so that any danger to persons, materials and products can be excluded.



Decommissioning

In the case of damage or malfunction of protective equipment, the fan is not to be used any more. It may only be put into operation again when the protective equipment is full functional again.



Electric power

When any work is done on the fan, the electric drive is to be isolated from the electrical supply and it is to be made sure that it cannot be reconnected. The main power switch has to be secured against operation by third parties using a lockable device (e.g. padlock) by the persons working on the fan. **The full disconnection of the motor is only permissible in case of complete removal!**
The safety regulations for work on electrical equipment in effect at the place of operation must be observed at all times and be available at the place of operation.



Electrostatic charge

Because of media flowing in the plastic components, electrostatic charges can build up. These are harmless for persons who do not respond to electrical impulses in the body.

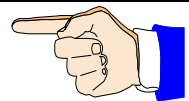

Unsuitable materials

Through the use of inappropriate materials, the fan and/or parts of it can be damaged or become non-operable. Please always use original spare parts and contact the manufacturer in any case of doubt.



Dangerous media

Depending on the mode of operation, fan parts are in contact with dangerous media. Work on the fan or the carrying out of maintenance work is not allowed during operation. Before carrying out any work, the system has to be freed from any dangerous media and, when required, to be neutralised and secured in such a way that an inflow of dangerous media is prevented.



1.9 EU conformity of the COLASIT fan

The fan was, built and tested to EC guidelines 2006/42/EC.

In addition to those EU guidelines and EN standards which have the status of a Swiss norm, Swiss safety and accident-prevention regulations have also been taken into account.

An EU Declaration of Conformity in terms of the EC guidelines 2006/42/EC on machines will be issued along with the fan.

1.10 Restrictions when commissioning

We stipulate that putting into operation is prohibited as long as the fan, including all parts belonging to it or equipment connected to it, has not been installed and checked out and until the operating manual has been read completely before commissioning.

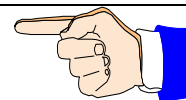

We stipulate that the fan may only be put into operation when the safety inspector has given his approval. He is obliged to record this approval in a protocol.

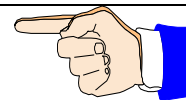

The disregard of these stipulations constitutes negligence.

1.11 General operating conditions

The disregard of these stipulations constitutes negligence.

The fan is not suitable for the transport of solids in the air flow. This operating mode will lead to the destruction of the fan.

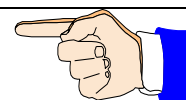

The ducts on the intake and delivery sides must always be open. A closed duct will lead to a rise in temperature which could cause the destruction of the fan.

The minimum air speed through the fan is 3 meters per second.

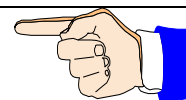

The standard motors are designed for normal operating conditions (ambient temperature. +40°C, location under 1000 m above sea level, air pressure up to 1050 hPa).

In the case of divergence from these conditions, please contact COLASIT.

Compliance with these operating conditions is the responsibility of the operator.

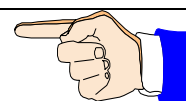

2 Explosion protection

COLASIT plastic fans are suitable for the conveyance of gases in Zone 1 or 2 (Equipment Category 2 or 3) depending on the model. COLASIT plastic fans are not suitable for the conveyance of gases in Zone 0 (Equipment Category 1).

The zone classification of the conveyed medium and the site of installation must be made known by the fan operator so that COLASIT can take the necessary measures to prevent the risk of ignition.

The explosion-proof COLASIT fans are not suitable for the conveyance of explosive dusts.

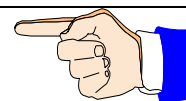

No modifications may be made to ATEX-certified fans. All work on the fan may only be carried out by ATEX-trained skilled personnel. Otherwise the ATEX Certificate will lose its validity.

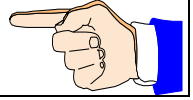

On ATEX certified fans, the external grounding terminal of the motor and fan must be connected to a potential equalization system.

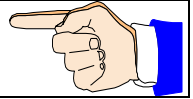

Motors with protection type "eb" are standard for using in the explosion-proof design of our fans. The standard version of the motors used complies with temperature class T3 (maximum surface temperature 200°C).

As special-purpose design, motors with protection type "db (oder db eb)" or motors with temperature class T4 (maximum surface temperature 135°C) are also available.

The user must define a suitable temperature class for his application that does not reach the ignition temperature of his conveyed medium.

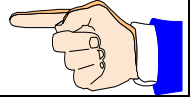

Please also observe the specifications in the operating instructions of the motor manufacturer. The thermal motor protection must be connected in compliance with the manufacturer's specifications (operating instructions).

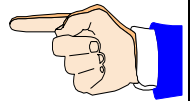

If a frequency converter is fitted, you have to use pressure-proof enclosed motors. In addition, a certified PTC resistor releasing device must be fitted. The following specifications must be included on the motor rating plate: min and max frequencies, min and max speeds, min and max torque or output, limit temperature PTC and PTC release time.



2.1 Fan EX marking

The Ex marking is located on the rating plate of each ATEX fan. On a fan of Equipment Category 2 (Zone 1), it looks like this:

CE  **II 2/3G Ex h IIB+H₂ T3 Gb/Gc**



CE-marking



Marking denoting prevention of explosions

II

Equipment Category II, for all Ex applications which do not fall in Class I (mines and surface workings).

2/3G

Equipment Category inside/outside the fan
Equipment Category 2 is the equivalent of Zone 1 and
Equipment Category 3 is the equivalent of Zone 2
"G" fan for the conveyance of explosive gases

Ex h

Protection type „design safety“

IIB+H₂

Equipment Category (gases)

T3

Temperature class T3: Max. surface temp. 200 °C
T4: Max. surface temp. 135 °C

Gb/Gc

Equipment Protection Level (EPL)

2.2 Correct installation of ATEX fan

The fan must be installed properly to guarantee trouble-free operation. To document proper installation, you will find a form on the last pages of this operating manual. The fitter must confirm the proper installation item for item on this form.

The signed form must be kept by the safety officer or operating company.

COLASIT also offers a comprehensive installation service for fans.

3 Shipping, unpacking, inspection

The fan is completely assembled and can be delivered in a closed foil wrapping.

Please make sure the delivery corresponds to the shipping documents.

Please examine the packaging for external damage and report damages immediately to the transport company, the supervisor and the manufacturer.

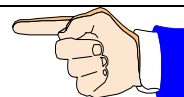

Please take caution when moving the fan. Plastics are sensitive to impact and knocks, especially in the temperature range under +5°C.

When the foil is removed, the intake and delivery connections are open and unprotected against the intrusion of foreign objects. Therefore, please do not remove the protective foil until shortly before definitive installation.

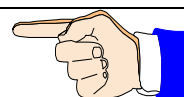

Storage

If the fans are not put into operation immediately, store them in a clean dry place where they are protected from impacts, vibrations, and temperature fluctuations and where the air humidity is under 90%.

If these storage conditions are not available, switch the fan on at regular intervals to exclude the risk of condensate forming. Before switching on, unscrew the condensate drain plugs each time and replace them afterwards.



Store the fan in a dry, weather-protected place and cover with a tarpaulin to protect it from dust and soiling. If stored for over one year, test whether the fan bearings rotate freely before putting into operation.

4 Installation, configuration

The fan is to be installed at a location provided and prepared by the customer and has to be secured and connected in such a way that any possible vibration occurring can be absorbed by the vibration absorbers provided by COLASIT.

If no ducting is foreseen on the intake side, the intake connection should be protected by a sturdy protective grating according to IP 20 (12 mm mesh) to be provided by the customer. If small particles can be sucked in which could cause damage to the fan, a protective grating with a correspondingly smaller mesh must be fitted. If the fan is used in a closed system where the possibility of sucking in foreign bodies is excluded, no protective grating must be fitted.

Connecting ducting on the delivery side must be mounted in such a way that no foreign objects, rainwater or condensate can run back into the fan. To ensure this, please use the COLASIT condensate drain unit.

Because of the possibility of noise exposure we recommend that the fan should not be installed in the immediate vicinity of workplaces.

5 Commissioning, initial start-up, test run

The fan should only be put into operation after inspection and approval by the safety inspector has taken place.

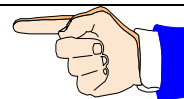

5.1 Inspection of the installation and settings

Check list:

Prior the commissioning and initial start-up, it must be guaranteed that:

- the fan is installed vibration-free and mechanically secured,
- all components are cleaned both on the inside and the outside and are free from foreign bodies,
- all intake and delivery ducts are connected in a leak-proof and elastic manner
- all rotating parts are protected against unintentional contacts,
- the electrical connections are installed and their function tested,
- a lockable revision switch is available to which the fan is connected,
- the equipment is functionally tested,
- the safety inspector has made sure that safety equipment exists,
- the operating personnel is familiar with the operating manual,
- the safety inspector has given his approval for the operation of the installation and that no external persons are present in the plant area.

If envisaged by procedural regulations provided by the operator, minutes have to be taken on the commissioning work, including the observance of the check list.

5.2 Drive

The fan is driven by an electrical motor which is connected either directly to the impeller shaft.

Data on the electrical connection of the motor are indicated on the motor's data plate or in the motor manufacturer's data sheet.

When speed is controlled by means of a frequency converter, the maximum rotational speed is limited by COLASIT to the value indicated on the manufacturer's plate.

If the frequency converter is not provided by COLASIT, the operator is responsible for the observance of the maximum rotational speed limit. In this case, COLASIT does not assume any liability for damage that can be attributed to exceeding the maximum rotational speed.

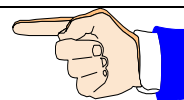

In order not to overload the fan mechanically, min. 15sec. acceleration and braking times must be observed.

Depending on the maximum available starting current of the frequency inverter, a longer acceleration time may be necessary to avoid an error message.

5.3 Electrical installations

The electrical installations may only be carried out by an authorised electrician in accordance with the regulations valid at the site at which the fan is installed.

For the interruption of the power supply, a revision switch is to be provided. It is advisable that this switch be mounted in the vicinity of the emergency exit.

Please request confirmation from the in-house electrician that the electrical installations were carried out and tested in accordance with regulations, that all functions have been tested (or simulated) and that the rotational direction is correct.

Caution

Do not turn power on or off without prior warning to persons in the area where the fan is operating. Switching operations must be co-ordinated with other functions in the working area of the fan.

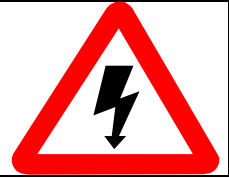

6 Operation

6.1 Safety regulations

The fan is to be operated according to this manual. In doing so, you will avoid possible damage.

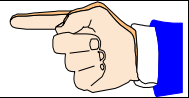

Supervision

The fan must not be operated unattended as long as it conveys substances, whose reactions are unknown or if unexpected reactions are to be anticipated. If the supervision has to be withdrawn for operational reasons, this has to be reported to the safety inspector and the plant has to be secured in such a way that no unauthorised manipulation can be carried out. The safety inspector decides on questions regarding supervision.



6.2 Decommissioning

An internal procedure instruction regulates the work to be carried out as well as the preparatory work for re-commissioning (e.g. cleaning).

7 Maintenance / repair / cleaning

7.1 Preparation

Before any work is carried out on the fan, it has to be brought into its "safety position".

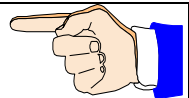

The „safety position“ is defined as follows:

- Drive is de-energised, the revision switch is secured against switching on,
- The fan impeller can be manually rotated,
- Fan flushed with fresh air and condensate-free,
- Fan is at room temperature,
- Personal protective equipment is available and its use is ordered. (Use of protective gloves because of sharp edges, ear protectors if necessary)
- A sign, e.g. „in revision“, is to be attached to the plant,
- The safety devices may be removed,
- The work to be carried out must not be done under time pressure
- The general and specific regulations on accident prevention as well as the EKAS guidelines (Switzerland) are to be observed,
- The safety inspector is informed about the nature and the course of the works.

If the intake and delivery ducts of the fan are dismantled for a longer period of time, the openings are to be closed off.

7.2 Performance

The fan must be maintained in accordance with the Maintenance Plan below. The maintenance work carried out must be noted down in the logbook (see the section on Logbook).

every week	every month	every year
<ul style="list-style-type: none"> • Make a visual inspection of fan for damage, leaks, corrosion and attachment. • Check the smooth running of the fan and electric motor. 	<ul style="list-style-type: none"> • Check the impeller and casing for deposits and clean if necessary. • Remove any dust deposits on the fan and motor. • Check the flexible transitions from fan to duct system for leaks and state. • Check the function of the condensate nozzle. • Check the state of the vibration dampers. • Check the state of the hub gasket (if fitted). 	<ul style="list-style-type: none"> • Carry out a thorough cleaning of the entire fan (including impeller). • Check the parts in contact with the conveyed medium for corrosion. • Check the minimum clearance between the impeller and casing (minimum 1% of intake diameter, maximum 20mm). • Check all screw unions for firm seating.

Normally the bearings are designed for a service life of 40,000 hrs. After this period the bearings must be replaced. The service life of the bearings is reduced when subjected to increased requirements (e.g. high temperature, aggressive ambient air or operation with frequency converter).

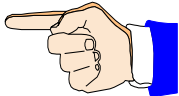

Components which are not intended for repair by the operator must be sent to the manufacturer or agent for repair or replacement (e.g. damaged impeller).

Your agent or COLASIT
also offers customer services

Manufacturer	COLASIT AG Faulenbachweg 63 CH 3700 Spiez / Switzerland
	Tel.: 0041 (0)33 655 61 61
	Fax.: 0041 (0)33 654 81 61
	e-mail info@colasit.ch
Agent	see front page

Deposits on the impeller and soiling lead to imbalance and as a result to vibrations with undesirable side effects.
If vibration occurs, switch the fan off immediately.

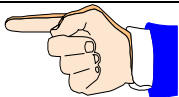

Contamination and encrustations should be removed with a soft tool without damaging the surface (e.g. with a wooden spatula or scraper). If possible, use water and a household cleaning agent.

Solvents can corrode the material. These may only be used with the written consent of COLASIT.

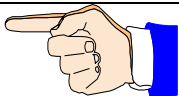

To carry out cleaning work, we recommend the production of a process instruction

8 Spare parts

Please identify components by means of the position and drawing numbers as well as the order number and type designation.

Use only original spare parts. Our warranty becomes null and void if other or unapproved components are used.

Please address your spare parts order to our customer service department.

9 Operating instructions

For the operation of the fan, we recommend the preparation of process instructions documentation. Such documents simplify repetitive workflows, reduce the risk of incorrect operation and are a valuable aid when personnel changes occur and for training.

If the fan must be qualified, process instruction documents are required.

You will find important notes on the preparation of process instructions in various chapters of the operating manual.

To help ensure the safe operation of the fan, COLASIT offers, as a service, the review of process instruction documents prepared by the operator.

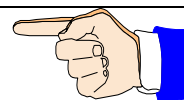

10 Log-book

For your own safety and as a contribution to personal responsibility, we recommend the keeping of a log book for the entire operation in which the fan is in use.

All events should be registered in the log book.

In the case of damage and also in the case of an accident, this document is the first source of information.

Please register the following together with, for example, date and signature:

- beginning and end of a work cycle
- special occurrences, even if these do not concern the fan itself (e.g. power failure, alarm)
- change of persons responsible for monitoring (e.g. in the case of shift operation)
- repairs carried out and spare parts installed
- decommissioning
- special instructions
- etc.

11 Disposal

Before disposing of plastics and other components, (complete or as broken parts), please clean them as necessary to preclude any danger to the environment.

Dispose of the components correctly. Instruct a waste-management company to do this or return them to us for disposal

12 Faults and fault clearance

If faults occur, we recommend that you identify and clear them using the following table.

If the fault cannot be cleared, please contact our customer service.

Operational fault	Possible causes	Remedy
Fan runs irregularly	Impeller is unbalanced	Re-balancing by a specialised company

Operational fault	Possible causes	Remedy
	Impeller caked up	Clean carefully, re-balance if necessary
	Material corrosion on impeller caused by conveying aggressive media	Consult the manufacturer
	Deformation of impeller because temperature too high	Consult the manufacturer
Leak at shaft bushing	Seal not suitable for application	Consult the manufacturer
Fan output too low	Wrong rotational direction of the impeller	Change direction of rotation
	Pressure loss in ducting too high	Different duct configuration
	Flow dampers are not or only partially opened	Check opening positions on the spot
	Inlet or delivery duct blocked	Remove obstacles
Fan does not reach its rated speed	Electrical control mechanisms are wrongly adjusted	Check adjustment of the motor protective device and if necessary re-adjust
	Motor winding is defective	Please consult manufacturer
	Drive motor is not correctly dimensioned	Please consult manufacturer for the purpose of checking starting torque
Grinding noises when fan is running or starting	Intake duct fitted under tension.	Remove intake duct and realign.

13 Retrofittable original accessories

If not already a part of our delivery, these original parts are available ex-stock for further ordering.

- Support

14 Fan identification

The following rating plate is affixed to each COLASIT fan:

- 1 Manufacturer
- 2 Field for CE marking and applicable standards
- 3 ATEX-identification, for details see the section on Explosion Protection
- 4 Fan specifications: fan type, casing design, material of casing and impeller, order number and date of manufacture.
- 5 Technical specifications

Part 2: Units

15 Design and function CCV 75

All impellers of this series are balanced out to better than G 6.3 according ISO 21940.
As a basic principle, plastic fans are not installed on the intake side in order to avoid leakage.

16 Dimensions

16.1 Dimensions of the CCV 75

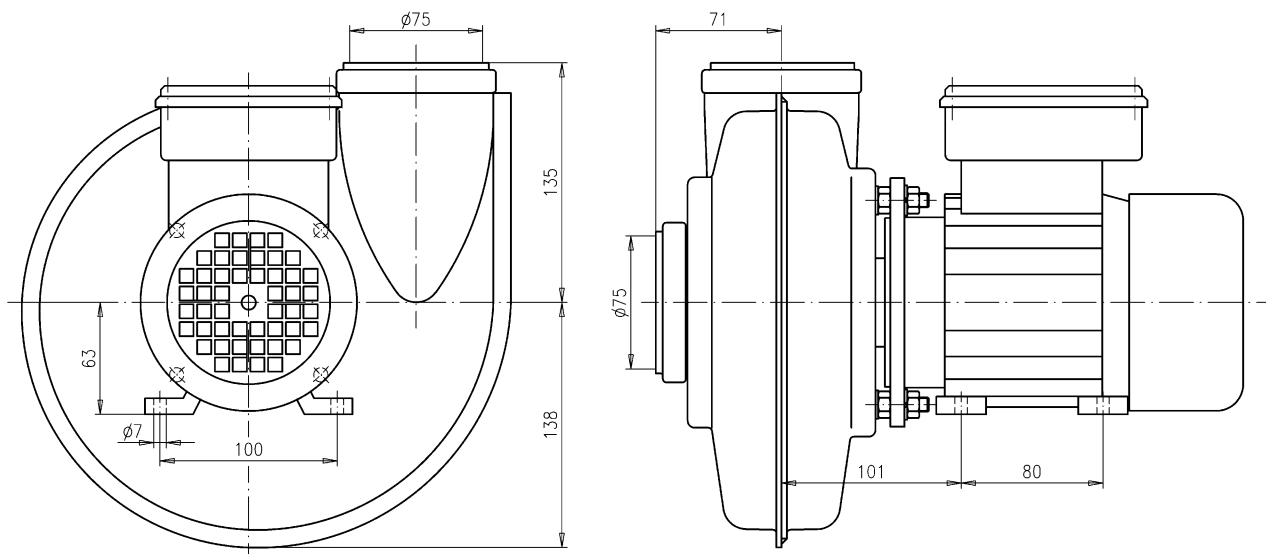

17 Spare parts

17.1 Spare parts lists CCV 75

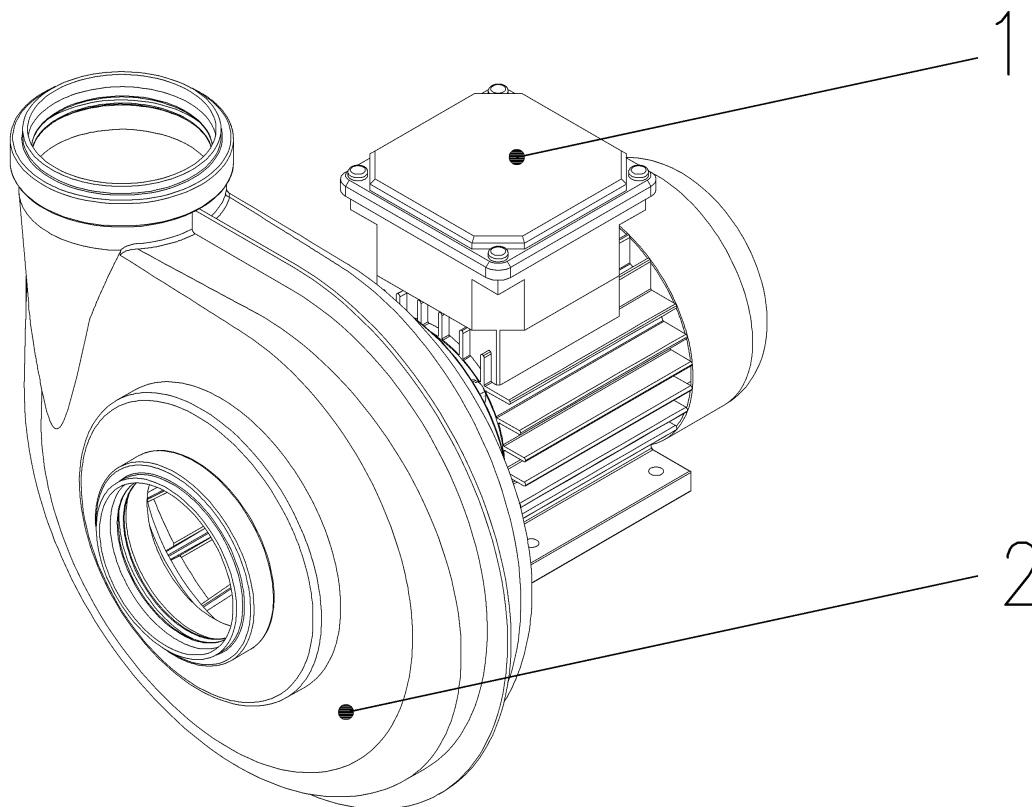

- 1 Motor
- 2 Fan

Part 3: Certifications

18 Certifications

18.1 EU Declaration of Conformity

EU-Konformitätserklärung

Déclaration UE de conformité

EU declaration of conformity

Wir

Nous

We

COLASIT AG

Faulenbachweg 63

CH-3700 Spiez

erklären in alleiniger Verantwortung, dass das Produkt
déclarons de notre seule responsabilité que le produit
bearing sole responsibility, hereby declare that the product

Kunststoff-Industrieventilator
Ventilateur industriel en plastique
Plastic industrial fan
CCV 75

auf das sich diese Erklärung bezieht, mit der/den folgenden Norm(en) oder normativen Dokumenten
übereinstimmt:

auquel se rapporte la présente déclaration est conforme aux normes ou aux documents normatifs suivants:
referred to by this declaration is in conformity with the following standards or normative documents:

Bestimmungen der Richtlinie Désignation de la directive Provisions of the directive	Titel und/oder Nummer sowie Ausgabedatum der Norm(en): Titre et/ou numéro ainsi que date d'émission de la/des norme(s): Title and/or number and date of issue of the standard(s):
2006/42/EG: Maschinensicherheit 2006/42/CE: Sûreté des machines 2006/42/EC: Machinery safety	EN ISO 12100: 2010 EN ISO 13857: 2019 EN 60204-1: 2018
2014/30/EU: Elektromagnetische Verträglichkeit 2014/30/UE: Compatibilité électromagnétique 2014/30/EU: Electromagnetic compatibility	EN IEC 61000-6-2: 2016
Name und Adresse des Dokumentationsverantwortlichen: Nom et adresse de la personne responsable de la documentation: Name and address of the person authorised to compile the relevant technical documentation:	Andreas Roth COLASIT AG Faulenbachweg 63 CH-3700 Spiez
Bei Verwendung im Ex-Bereich Pour utilisation dans zone Ex For use in Ex zones	
2014/34/EU: Geräte und Schutzsysteme zur bestimmungsgemässen Verwendung in explosionsgefährdeten Bereichen 2014/34/UE: Appareils et système de protection destinés à une utilisation correcte en atmosphère explosibles 2014/34EU: Equipment and protective systems intended for use in potentially explosive atmospheres	EN 1127-1: 2019 EN 80079-36: 2016 EN 80079-37: 2016 EN 14986: 2017
Ex-Kennzeichnung: Marquage Ex: Ex Marking:	 II 3/- G Ex h IIB+H₂ T3 T4 Gc/- II 3/3 G Ex h IIB+H₂ T3 oder T4 Gc II 2/3 G Ex h IIB+H₂ T3 ou T4 Gb/Gc II 2/2 G Ex h IIB+H₂ T3 T4 Gb T3/T4 gem. Typenschild T3/T4 selon la plaque signalétique T3/T4 acc. to the rating plate

Spiez, 31.05.2021



U. Moser (Geschäftsführer/directeur/chief executive officer)

ATEX-Konformitätsaussage

Equipment, components and protection systems for use for their intended purpose in explosion protected zones – **Directive RL 2014/34/EC (ATEX)**

Document number: **TD-000 783**
Product designation: Medium pressure radial fan CCV 75 ATEX
Manufacturer: COLASIT AG
Postfach 85
3700 Spiez
Product description: Plastic industrial fan for the conveyance of chemically aggressive gases, vapour or correspondingly contaminated air.

The conformity assessment process was conducted in compliance with Directive 2014/34/EU (ATEX). The results are recorded in the confidential **Test Report TD-000 784**. All related documents are kept at the centres named below:





named centre 1258
Eurofins Electric & Electronic Product Testing AG
Luppenstrasse 3
CH – 8320 Fehraltorf

COLASIT hereby certifies compliance with the basic health and safety requirements for the design and manufacture of equipment and protection systems for use for their intended purpose in explosive atmospheres in compliance with Annex II of the Directive.

The following harmonised standards were applied:

EN 1127-1: Explosive atmospheres – Explosion protection, Part 1, 2019
EN ISO 80079-36: Non-electrical equipment for potentially explosive atmospheres, Part 36, 2016
EN ISO 80079-37: Non-electrical equipment for potentially explosive atmospheres, Part 37, 2016
EN 14986: Design of fans working in potentially explosive atmospheres, 2017

The marking on the appliance must comprise the following information:

-  II 3/-G Ex h IIB+H₂ T3 or T4 Gc/- (conveyed medium Zone 2, site of installation no Zone)
-  II 3/3G Ex h IIB+H₂ T3 or T4 Gc (conveyed medium Zone 2, site of installation Zone 2)
-  II 2/3G Ex h IIB+H₂ T3 or T4 Gb/Gc (conveyed medium Zone 1, site of installation Zone 2)
-  II 2/2G Ex h IIB+H₂ T3 or T4 Gb (conveyed medium Zone 1, site of installation Zone 1)

The associated operating instructions contain important safety instructions and regulations for putting the named equipment into operation in compliance with Directive 2014/34/EU (ATEX).

Changes to the named equipment are prohibited except with the manufacturer's express approval in writing.

If the named equipment is built into a higher level machine, the new risks ensuing from the integration must be assessed by the manufacturer of the new machine.

Spiez, 31.05.2021



Andreas Roth

Authorised representative for documentation



Urs Moser

On behalf of the executive management

Enclosure

Declaration of Conformity No. TD-000 783

Description of appliance or protective system:

The radial fans CCV 75 ATEX extract room air or process exhaust air. They are directly driven by electric motors.

Special conditions:

If the fans are operated within explosive atmospheres in Zone 1 or 2, they may only be driven by motors for which an appropriate approval (EC type examination certificate) has already been issued.

Temperature Class T4: If the site of installation is Zone 1/2, an explosion proof motor with temperature class T4 must be fitted. If an explosion proof motor with temperature class T3 is used, temperature class 3 shall apply to the entire fan.

Ambient temperature: T -20 - 40°C
Maximum temperature of intake medium: 60°C

The minimum flow velocity through the fan must be minimum 3m/s.

All service and repair work must be carried out by trained service personnel.

Additional information:

The radial fans of Equipment Category 3 may only be used to extract gases where the frequency of occurrence of combustible or explosive atmospheres is equivalent to Ex-Zone 2.

Basic safety and health requirements:

Fulfilled by standards.

This certificate may only be copied in full without any changes.

18.3 Further certificates

This operating manual has the following certificates enclosed:

- Datasheet of the fan

If ATEX version additionally:

- ATEX Certification/Inspection report for fan (see 18.2)
- ATEX Certification/Inspection report for electric motor (if this was supplied by COLASIT)

19 Form for the correct assembly ATEX-fans

With ATEX-certified fans, this form must be completed by the fitting team. It serves to verify the proper mounting of the fan and its operating conditions. The completed form must be kept by the safety officer or operating company. It forms the basis of a test voucher quality system which is stipulated by standard EN 14986 (Design of fans for use in explosive atmospheres).

The fitting team shall certify that they have properly executed the following work:

- The fan is mounted on suitable vibration dampers. They are mechanically secured so that the fan cannot slip away or wander.
- The intake and pressure ducting are connected close to the fan.
- With free intake/blow off fans, a protective grating with a mesh width of 10mm is fitted.
- The clearance between the impeller and the casing is min 5mm and max 20mm.
- All rotating parts are protected against unintentional contact.
- The fan is installed so that the motor is supplied with sufficient cooling air (distance to walls, etc.)
- The motor is properly connected in accordance with the manufacturer's instructions (operating manual). The same applies to the PTC resistor, if fitted.
- The motor and the fan is connected to a potential equalisation system.

Test run:

- The minimum air flow through the fan is min 3 m/s and max 30m/s.
- The maximum vibration velocity in operation is not greater than 5.1mm/s measured at the bearings (V-belt drive) or the motor (direct drive).
- The operating temperature is lower than the maximum permitted operating temperature specified on the rating plate.
- The motor current draw is lower than the rated current specified on the rating plate.

If one or more of the works listed above cannot be carried out, please contact the supplier of the manufacturer.

Company name:

Order number:

Fan type:

Name of fitter:

Place and date:

Signature: